

MODELLING MICROWAVE TRANSISTOR CHAOS GENERATORS

Alexander S.Dmitriev (*member IEEE*), Elena V.Efremova and
Alexander D.Khilinsky

Institute of RadioEngineering and Electronics, Russian Academy of Sciences,
Mokhovaya St. 11-7, 101999, Moscow, Russia,
E-mail: chaos@mail.cplire.ru

Abstract –

Microwave chaotic generators based on three-point circuit are analyzed. Principles of design of model-based generator from low to microwave frequency range are discussed. Special attention is given to transition to high frequency range using similarity principle and preserving the map of dynamic regimes. Three transistor models are analyzed, including SPICE model and Gummel-Poon model. The correspondence of models is discussed. The results of modelling in frequency range from several kHz up to several GHz are reported.

Index terms – Dynamic chaos, chaotic oscillator, modelling, EDA, microwave oscillator, VCO

1. Introduction

Using dynamical chaos in radiolocation and radio communication [1-6] demands creation of sources of chaotic oscillations with predefined statistical, spectral and other properties.

Dynamic chaos could be obtained in electronic schemes with 1.5 degrees of freedom with single nonlinear element – transistor. The model of chaotic source with bipolar transistor is proposed in [7]. Later it has been discovered that chaotic oscillations could be implemented in classical three-point scheme with one and a half degrees of freedom [8]. The capacitance variant of this scheme (Colpitts oscillator) is considered in [9].

Three-point scheme is a good base element for chaos generators. First, this type of scheme is thoroughly studied as a generator of regular oscillations. Second, relative simplicity of this scheme enables thorough study of principles of modelling of microwave chaotic generators. Third, this scheme is also rather general and can be elaborated and modified in a number of ways.

The paper studies the principles of modelling of three-point scheme of microwave chaotic generators. The modelling has been carried out in the Advanced Design System (ADS) package and results are reported.

2. Three-point scheme of generator

The mathematical model for three-point scheme is described as follows [8-9]:

$$\begin{aligned} C_1 \frac{dV_{C_1}}{dt} &= -\alpha_F f(-V_{C_2}) + I_L \\ C_2 \frac{dV_{C_2}}{dt} &= (1 - \alpha_F) f(-V_{C_2}) + I_L - I_0 \\ L \frac{dI_L}{dt} &= -V_{C_1} - V_{C_2} - RI_L + V_{cc} \end{aligned} \quad (1)$$

Here V_{C_1} - voltage at C_1 capacitor, V_{C_2} - voltage at C_2 capacitor, I_L - current through L inductor, f - nonlinear characteristics of the transistor, α_F - ratio of collector current to emitter current. Note that $\alpha_F \approx 1$ for most transistors.

Let $\alpha_F = 1$, i.e. neglect base current. For our purposes, this approximation is rather fair.

It is usual to describe transistor characteristics as follows:

$$I_E = f(V_{BE}) = I_S \exp\left(\frac{V_{BE}}{U_T}\right) \quad (2)$$

Three-point scheme of generator with transistor as nonlinear element is depicted at Fig. 1. The system for studying high-frequency communication schemes – ADS – is used for modelling.

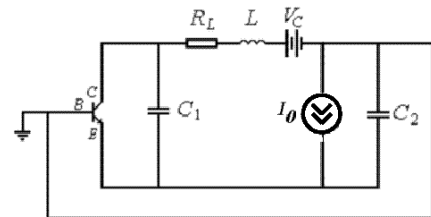

Fig. 1. Three-point scheme of generator with current source in emitter circuit.

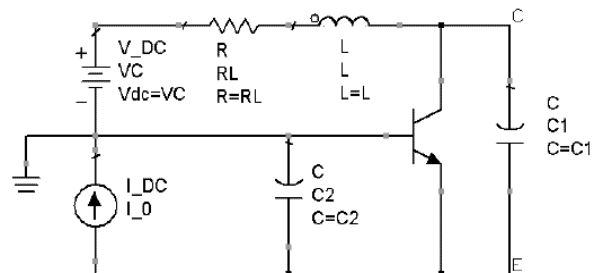

Fig. 2. Three-point scheme of generator. Representation in ADS.

The representation of this scheme in ADS is shown at Fig. 2.

3. Transistor models

Three transistor models are employed for studying high-frequency chaotic generators:

- simple static model with exponential transistor characteristics
- SPICE model
- Gummel-Poon model

The first model is used for comparison of modelling results for generators with simple transistor model and complex real-type transistor models. SPICE models are used for representation of low-frequency transistor in ADS. Gummel-Poon model is used for representation of high-frequency transistors in ADS.

The **simple static model** is described by the following equation:

$$I_C = I_S \cdot [\exp(V_{BE}/U_t) - 1], \quad (3)$$

where $U_t = kt/q = 25.3$ mV at room temperature, $I_S = a \cdot I_O \approx I_O$ – saturation current of transistor. I_O is reverse current of emitter junction. In active region $I_C \gg I_S$ and term «-1» could be ignored. Base current could be approximately defined as:

$$I_B = I_C/b \quad (4)$$

Coefficients **a** and **b** are related:

$$a = \frac{b}{1+b} \quad (5)$$

Typically, $b \sim 100...200$, $a \approx 1$.

Gummel-Poon model [10] is a dynamical transistor model. Parameters of this models account for nonlinear effect at high frequencies, parasitic capacitances, temperature dependence, etc. Equivalent circuit for this model is depicted at Fig. 3.

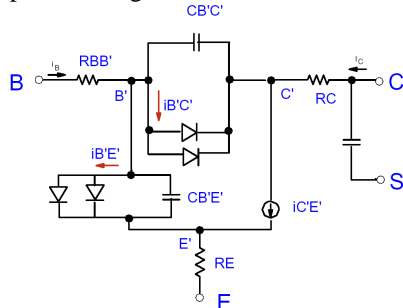

Fig. 3. Equivalent circuit for Gummel-Poon model.

For comparison between Gummel-Poon model and the model with exponential characteristics two parameters are used: forward current gain **b** and saturation current I_S . These parameters are available in

both models.

4. Modelling low-frequency generators

We have studied three-point circuits with 2N2222 and BFP620 transistors at low frequencies.

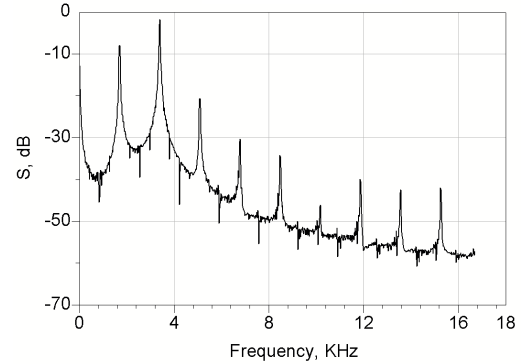

Fig. 4. Power spectrum in three-point circuit with SPICE model of 2N2222 transistor. Frequency range – kilohertz.

First, the scheme has been studied at frequencies as low as several kilohertz for 2N2222 transistor. There have been examples of implementation of generator at this transistor at frequencies of 100 kHz [8], which could be used as basis for comparison.

The power spectrum is shown at Fig. 4 for three-point scheme with SPICE model of 2N2222 transistor (the model is utilized from standard ADS library).

The static model with exponential transistor characteristics for 2N2222 transistor has been studied, namely. The goal has been to evaluate how relatively simple model might grasp the nuances of behavior of more complex SPICE model.

The bifurcation diagram for three-point scheme with static model with exponential characteristics is shown at Fig. 5. One can see the regions of complex behavior between windows with cycles with period of three.

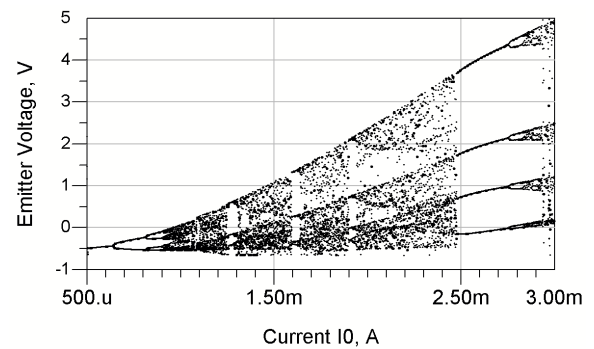

Fig. 5. Bifurcation diagram for three-point scheme with the model with exponential characteristics for 2N2222 transistor. Frequency range – kilohertz.

The certain degree of similarity is discovered between dynamical regimes of generators with two models: SPICE model and the model with exponential characteristics. This fact justifies the use of simple transistor models for description of low-frequency generators.

Then the scheme has been studied with **BFP620** transistor. This transistor is more viable at high frequencies, so such study could be useful for comparison between high- and low-frequency dynamical regimes. The bifurcation diagram for the Gummel-Poon model of this transistor is shown at Fig. 6.

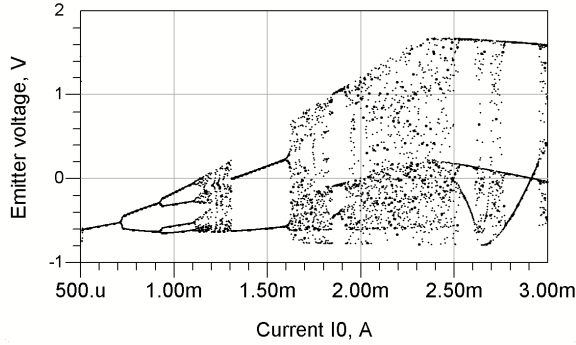

Fig. 6. Bifurcation diagram for three-point scheme with Gummel-Poon model of BFP620 transistor. Frequency range – kilohertz.

5. The peculiarities of increasing of frequency.

Our goal at this section is to increase frequency of oscillations and to track the changes in dynamical regimes.

The procedure has been developed and tested for such increase in frequency. Namely, the parameters of the scheme have been changed according to the following procedure. The parameters C_1 , C_2 , L are to be decreased in γ times, where γ - the factor of frequency increase:

$$\begin{aligned} C'_1 &= C_1 / \gamma, \\ C'_2 &= C_2 / \gamma, \\ L' &= L / \gamma. \end{aligned} \quad (6)$$

This procedure is illustrated at Fig. 7 (a)-(c).

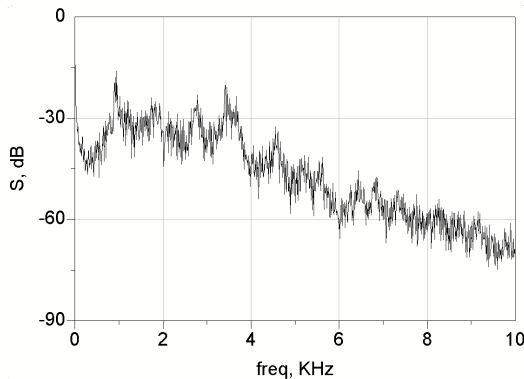

Fig. 7 (a). Power spectrum in three-point circuit with Gummel-Poon model of BFP620 transistor. Frequency range – kilohertz. $\gamma = 2$.

The power spectra are shown for three-point scheme at various fundamental frequencies. The parameters have been changed according to the procedure, described above. One can see evident similarity in power spectrum between different frequencies, which supports the procedure proposed.

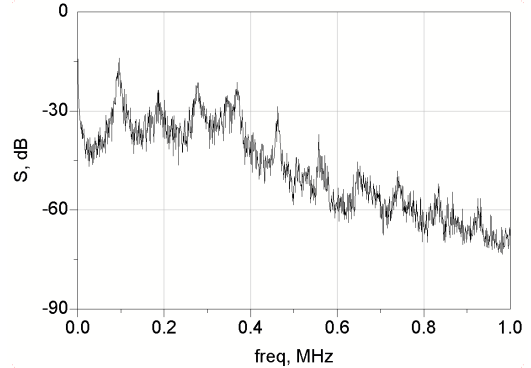

Fig. 7 (b). Frequency range – hundreds of kilohertz. $\gamma = 200$.

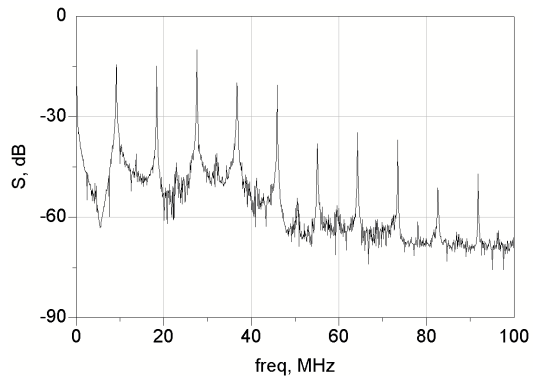

Fig. 7 (c). Frequency range – megahertz. $\gamma = 2000$.

Even at such relatively high frequencies complex dynamical regimes are present in the system. The bifurcation for megahertz frequency range is shown at Fig. 8.

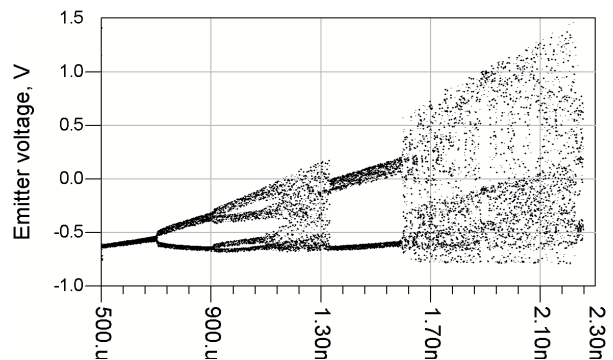

Fig. 8. Bifurcation diagram for three-point scheme with Gummel-Poon model of BFP620 transistor. Frequency range – megahertz.

6. Modelling chaotic generators in microwave range.

Consider three-point scheme with BFP620 Si-Ge transistor at frequencies as high as several gigahertz. The power spectrum for this system is shown at Fig. 9.

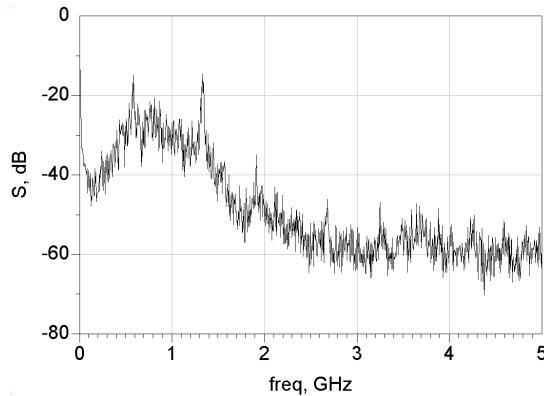

Fig. 9. Power spectrum in three-point circuit with BFP620 transistor.

The phase portrait of this scheme is shown at Fig. 10.

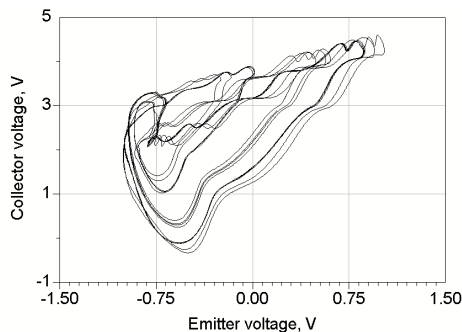

Fig. 10. Fragment of phase portrait of three-point scheme with BFP620 transistor.

4. Conclusions

The paper studied three-point scheme as a platform for microwave generators. We have evaluated three transistor models. The principles of modelling from low up to high frequencies were discussed. The possibility is shown for creation of chaotic generator at frequencies as high as several gigahertz.

This report is supported in part by a grant from Russian Foundation for Fundamental Research (N 03-02-16747, N 02-02-16802).

References

- [1] *Kosarev L., Halle K.S., Eckert K., Chua L., Parlitz U.* «Experimental demonstration of secure communications via chaotic synchronization» // *Int. J. Bifurcation and Chaos*. 1992. V. 2. N 3. P. 709.
- [2] *Cuomo K. and Oppenheim A.* «Circuit implementation of synchronization chaos with applications to communications» // *Phys. Rev. Lett.* 1993. V. 71. N 1. P. 65.
- [3] *Belsky Yu.L., Dmitriev A.S.* «Information transmission with deterministic chaos», *Radiotekhnika i Elektronika*, 1993, V.38, N7, p.1310-1315.
- [4] *Dmitriev A.S., Panas A.I., Starkov S.O.* «Dynamical chaos as paradigm of contemporary communication systems», *Zarubezhnaya Radioelektronika, Uspehi sovremennoy radioelektroniki*. 1997. N10. p.4-26.
- [5] *Bauer A., Kiliyas T., Schwarz W.* «Chaotic bit stream generators for pulstream radar application» // *Proc. 5th Int. Workshop Nonlinear Dynamics of Electronic Systems (NDES-1997)*, June 26-27, 1997, Moscow, M.: A.S. Popov Society, P. 410.
- [6] *Kislov V.Ya.* «Dynamical chaos and its use in radioelectronics for generation, receiving and processing of oscillations and information», *Radiotekhnika i Elektronika*, 1993, V.38, N 10, p. 1783- 1815
- [7] *Dmitriev A.S., Ivanov V.P., Lebedev M.N.* «Transistor generator model with chaotic dynamics» // *Radiotekhnika i Elektronika*. 1988. V. 33. N 5. P. 1085.
- [8] *Kennedy M.* «Chaos in Colpitts oscillator» // *IEEE Trans.* 1994. V. CS-41. N. 11. P. 771.
- [9] *Feo O., Maggio G., Kennedy M.* The Colpitts oscillator: families of periodic solutions and their bifurcations // *Int. J. of Bifurcation and Chaos*. 2000. V. 10. N 5. P. 935-958.
- [10] *P. Antognetti and G. Massobrio*, *Semiconductor device modeling with SPICE*, New York: McGraw-Hill, Second Edition 1993.